

User Manual

Revision v1.3 July 2009

Point-of-Sale Hardware System

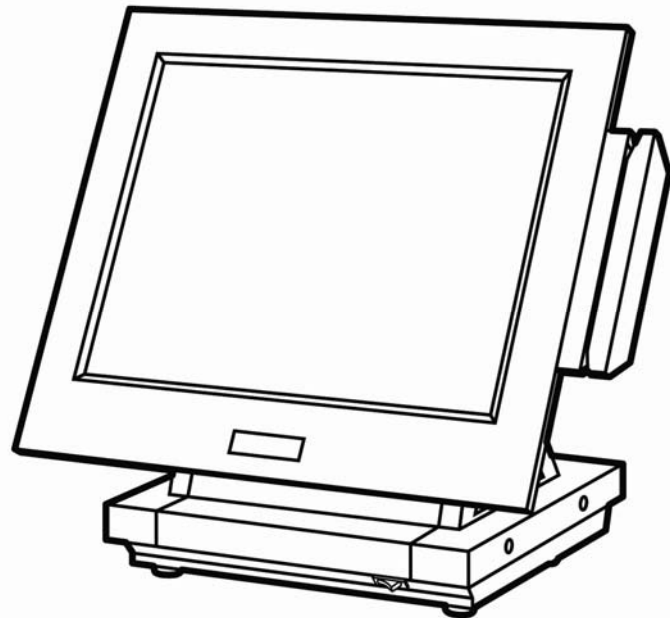

Copyright 2009 July
All Rights Reserved
Manual Version 1.3
P/N: 3LMPP3600313

The information contained in this document is subject to change without notice.

We make no warranty of any kind with regard to this material, including, but not limited to, the implied warranties of merchantability and fitness for a particular purpose. We shall not be liable for errors contained herein or for incidental or consequential damages in connection with the furnishing, performance, or use of this material.

This document contains proprietary information that is protected by copyright. All rights are reserved. No part of this document may be photocopied, reproduced or translated to another language without the prior written consent of the manufacturer.

TRADEMARK

Intel®, Pentium® and MMX are registered trademarks of Intel® Corporation. Microsoft® and Windows® are registered trademarks of Microsoft Corporation.

Other trademarks mentioned herein are the property of their respective owners.

Safety

IMPORTANT SAFETY INSTRUCTIONS

1. To disconnect the machine from the electrical power supply, turn off the power switch and remove the power cord plug from the wall socket. The wall socket must be easily accessible and in close proximity to the machine.
2. Read these instructions carefully. Save these instructions for future reference.
3. Follow all warnings and instructions marked on the product.
4. Do not use this product near water.
5. Do not place this product on an unstable cart, stand, or table. The product may fall, causing serious damage to the product.
6. Slots and openings in the cabinet and the back or bottom are provided for ventilation; to ensure reliable operation of the product and to protect it from overheating. These openings must not be blocked or covered. The openings should never be blocked by placing the product on a bed, sofa, rug, or other similar surface. This product should never be placed near or over a radiator or heat register, or in a built-in installation unless proper ventilation is provided.
7. This product should be operated from the type of power indicated on the marking label. If you are not sure of the type of power available, consult your dealer or local power company.
8. Do not allow anything to rest on the power cord. Do not locate this product where persons will walk on the cord.
9. Never push objects of any kind into this product through cabinet slots as they may touch dangerous voltage points or short out parts that could result in a fire or electric shock. Never spill liquid of any kind on the product.

CE MARK



This device complies with the requirements of the EEC directive 2004/108/EC with regard to “Electromagnetic compatibility” and 2006/95/EC “Low Voltage Directive”.

FCC

This device complies with part 15 of the FCC rules. Operation is subject to the following two conditions:

- (1) This device may not cause harmful interference.
- (2) This device must accept any interference received, including interference that may cause undesired operation.

CAUTION ON LITHIUM BATTERIES

There is a danger of explosion if the battery is replaced incorrectly. Replace only with the same or equivalent type recommended by the manufacturer. Discard used batteries according to the manufacturer's instructions.

LEGISLATION AND WEEE SYMBOL

2002/96/EC Waste Electrical and Electronic Equipment Directive on the treatment, collection, recycling and disposal of electric and electronic devices and their components.

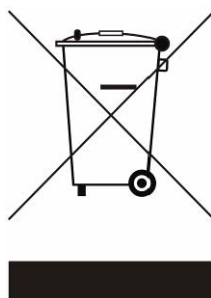

The crossed dustbin symbol on the device means that it should not be disposed of with other household wastes at the end of its working life. Instead, the device should be taken to the waste collection centers for activation of the treatment, collection, recycling and disposal procedure.

To prevent possible harm to the environment or human health from uncontrolled waste disposal, please separate this from other types of wastes and recycle it responsibly to promote the sustainable reuse of material resources.

Household users should contact either the retailer where they purchased this product, or their local government office, for details of where and how they can take this item for environmentally safe recycling.

Business users should contact their supplier and check the terms and conditions of the purchase contract.

This product should not be mixed with other commercial wastes for disposal.

Revision History

Changes to the original user manual are listed below:

Version	Date	Description
1.0	2007 March	<ul style="list-style-type: none">• Initial release
1.1	2007 May	<ul style="list-style-type: none">• System Disassembly updated
1.2	2007 September	<ul style="list-style-type: none">• Cover page updated• Connector Pin Definition updated
1.2a	2007 September	<ul style="list-style-type: none">• Cash Drawer Power Setting Correction
1.2b	2008 June	<ul style="list-style-type: none">• Cash Drawer Power Setting Correction• Updated specification with Second Display options• Updated Optional Items with Second Display options• Updated LCD ID jumper settings
1.3	2009 July	<ul style="list-style-type: none">• Motherboard B78 v1.0 updated to v2.2• 2nd display installation added• VFD installation added• SATA HDD photo added• 2-in-1 MSR + iButton module added• 2-in-1MSR + Finger Printer module added.• Remove Ventilation slots from rear cover.

Table of Contents

1	Item Checklist	1
1-1	Standard Items	1
1-2	Optional Items	2
2	System View.....	3
2-1	Front View	3
2-2	Side View.....	4
2-3	Rear View	4
2-4	Bottom View	5
2-5	I/O View	5
3	Driver Installation	6
3-1	Driver List	6
3-2	Chipset Driver Installation	7
3-3	USB 2.0 Driver Installation.....	8
3-4	VGA Driver Installation.....	11
3-5	Audio Driver Installation.....	12
3-6	10/100/1000MB LAN Driver Installation.....	13
3-7	ELO Touch Driver Installation	14
3-8	POSTouch Driver Installation.....	17
4	Peripherals Installation	21
4-1	MSR Module Installation.....	21
4-2	2-in-1 MSR + Finger Print Module Installation	23
4-3	2-in-1 MSR + iButton Module Installation.....	23
4-4	Second Display Installation.....	24
4-5	VFD Installation	25
4-6	Cash Drawer Installation.....	27
5	System Disassembly	29
5-1	Replacing SATA HDD	29
5-2	Replacing the CF Card Holder (Optional)	30
5-3	Replacing Motherboard & I/O Board.....	31
5-4	Replacing Inverter Board & Touch Screen Board	33
6	Specification	35
7	Jumper Settings	37
7-1	B78 v2.2 Jumper Settings.....	38

8 BIOS Settings.....	43
8-1 BIOS Setup Utility	43
8-2 Starting the BIOS Setup.....	43
8-3 When a Problem Occurs.....	43
8-4 BIOS Main Menu	43

1 Item Checklist

Take the system unit out of the carton. Remove the unit from the carton by holding it by the foam inserts. The following contents should be found in the carton:

1-1 Standard Items

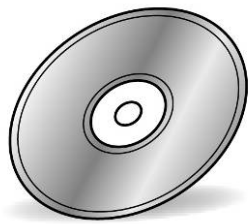

a. Driver CD

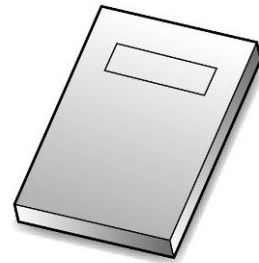

b. User Manual

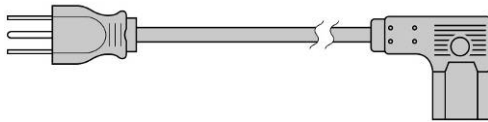

c. Power Cable

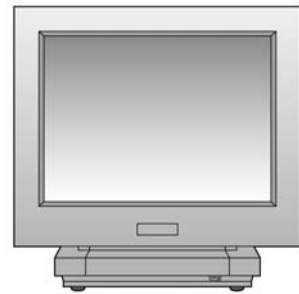

d. System

1-2 Optional Items



a. CF card holder



b. MSR



c. 2-in-1 MSR + Finger Print Module



d. 2-in-1 MSR + iButton Module



e. 10.4", 12.1" LCD Second Display



f. VFD

2 System View

2-1 Front View

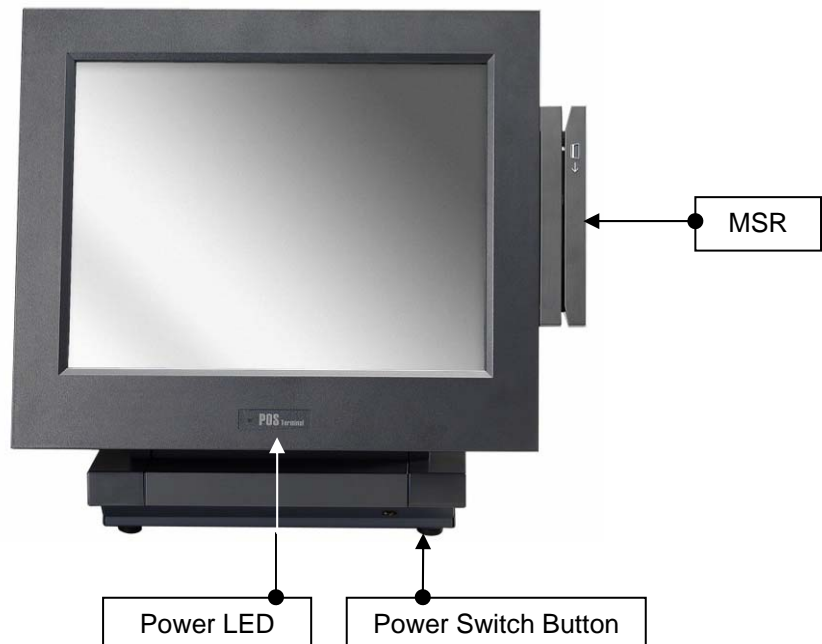

2-2 Side View

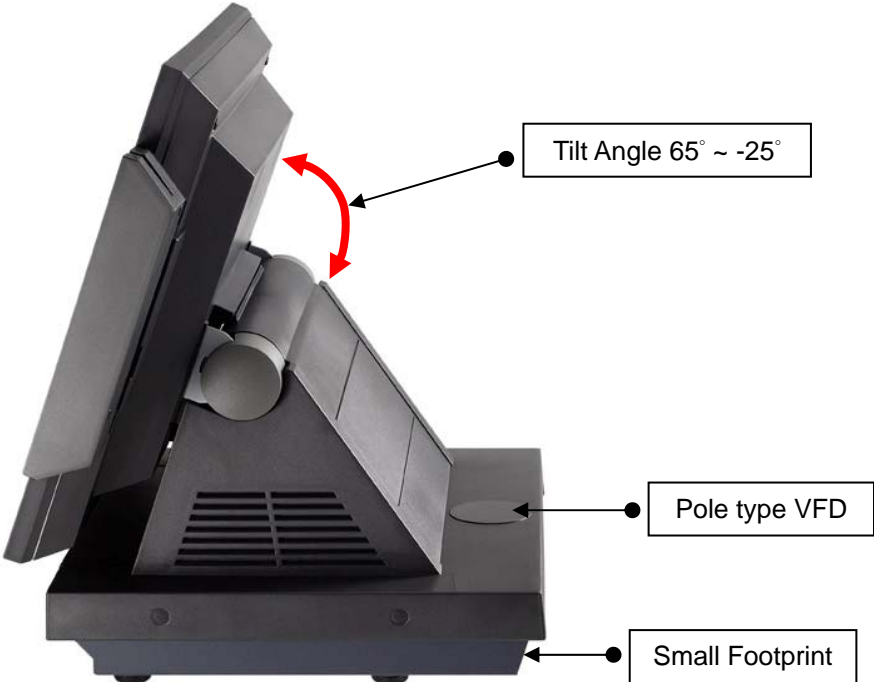

2-3 Rear View

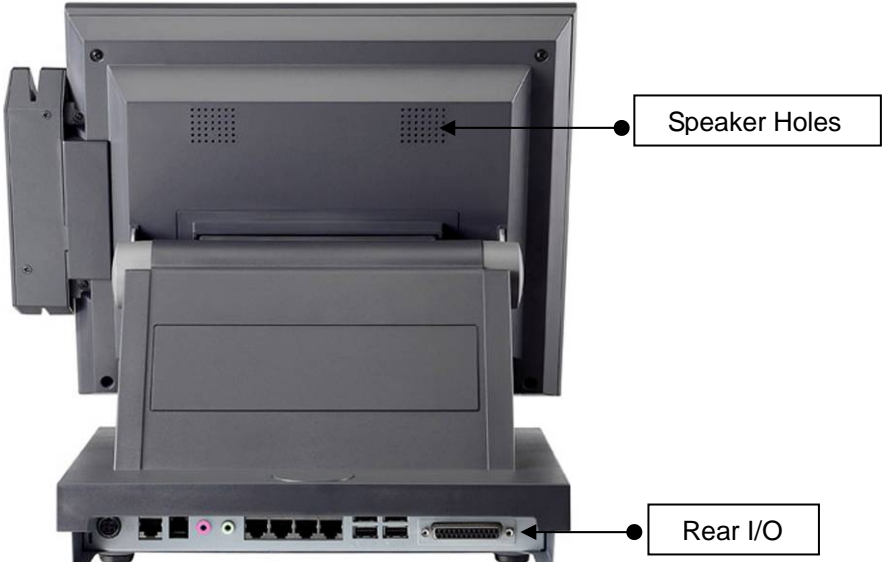

2-4 Bottom View

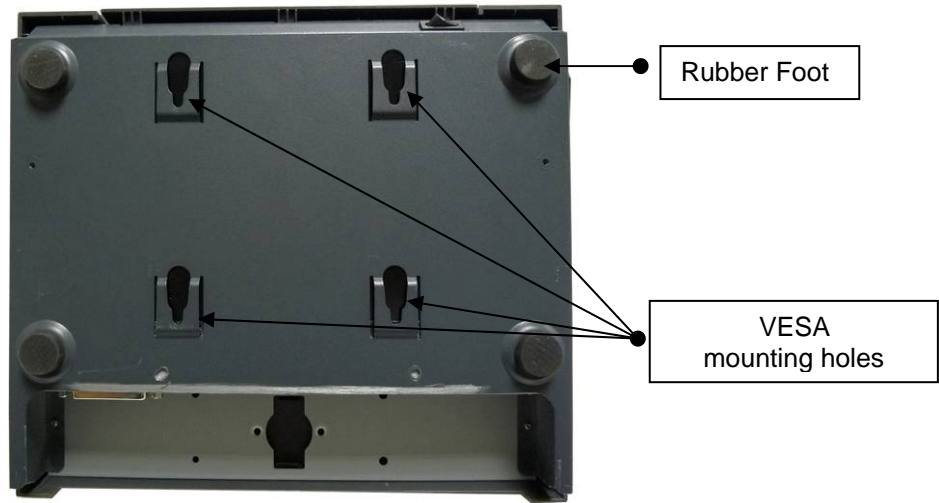

2-5 I/O View

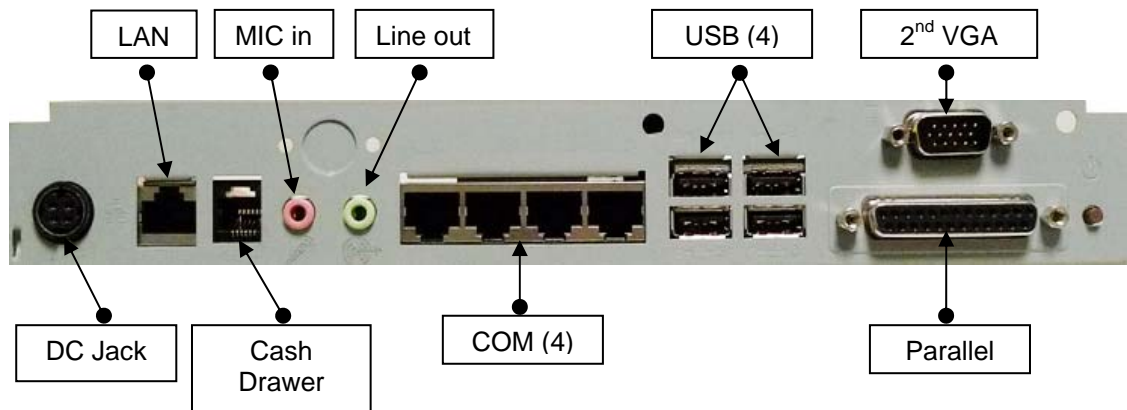

Note: The maximum current that can be drawn from each COM port is 500 mA.

3 Driver Installation

3-1 Driver List

B78 V2.2 Driver List

Folder/File	File Description
<CD>:\ POS360_B78.htm	Driver List
<CD>:\COMMON\INTEL\Chipset\i8xx	Chipset Driver
<CD>:\COMMON\INTEL\USB20	USB 2.0 Driver
<CD>:\COMMON\INTEL\VGA\i85x	VGA Driver
<CD>:\COMMON\Ac97_codec\Realtek\ALC202A	Audio Driver
<CD>:\COMMON\ POS_Touch	POSTouch Driver
<CD>:\COMMON\ELO_Touch	ELO Touch Driver
<CD>:\COMMON\Lan_driver\Realtek_PCI	10/100/1000Mb LAN Driver

-The following procedures are for Windows 2000/XP, other platforms are similar.

3-2 Chipset Driver Installation

Model name (Motherboard)	Function	OS	Note
(B78)	Chipset	Windows	
	USB 2.0	Win9x_ME	
		Win2K	
		WinNT4	
	VGA	Win9X_ME	Version: 14.19.50
		Win2K_XP	
		Linux	
		WinNT4	
	Audio	Win9X_ME_2K_XP	
		Vista	
	Linux		

a. Click "Chipset" in the Driver List menu of POS360 B78.

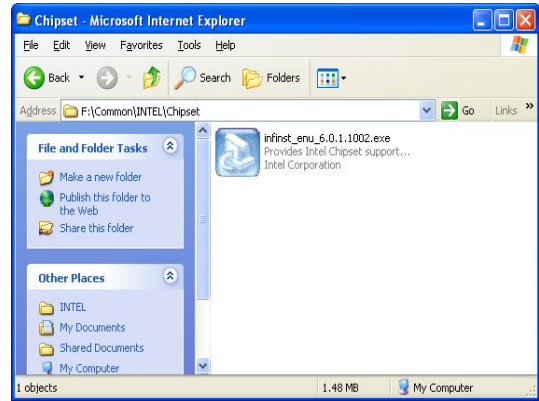

b. Double-click "infinst_enu_6.0.1.1002.exe" on the My computer window.

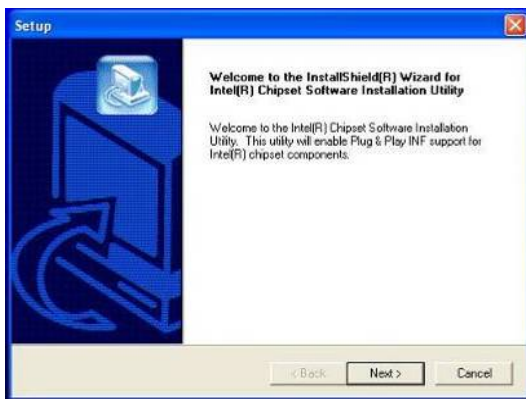

c. Click the "Next" button on the Welcome window.



d. Click the "Yes" button on the License Agreement window.

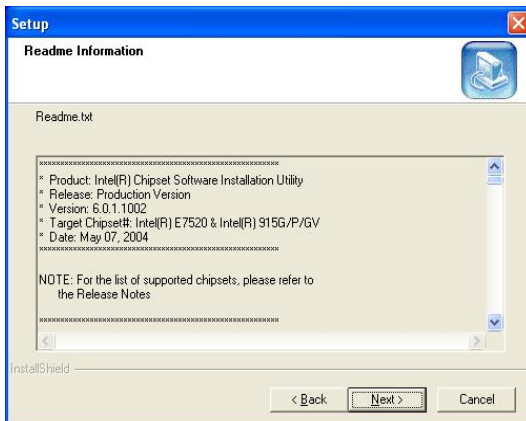

e. Click the "Next" button on the Readme Information window.



f. Click the "Finish" button and restart your system.

3-3 USB 2.0 Driver Installation

OS Requirements

OS	USB 2.0 requirements
Windows XP	USB 2.0 drivers are provided in Service Pack 1 (SP1) for Windows XP, which is available through Windows Update .
Windows 2000	USB 2.0 drivers are available through Windows Update or Service Pack 4.
Windows 98SE/Me	USB 2.0 drivers are available on the Intel developer site .
Windows 98 (Retail)	Developers and OEMs should contact Orange Ware . For end-users, if your device does not ship with Windows 98 drivers, contact your device or system manufacturer. If USB 2.0 drivers are not available, your device will operate at USB 1.1 speeds
Linux	USB 2.0 support is available in kernel 2.4.19 or later development kernels, or in the 2.4.19 or later production kernel. More information .

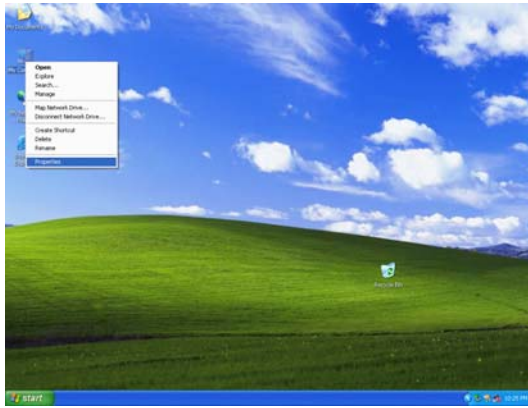

a. Right click My Computer on the desktop and select "properties"

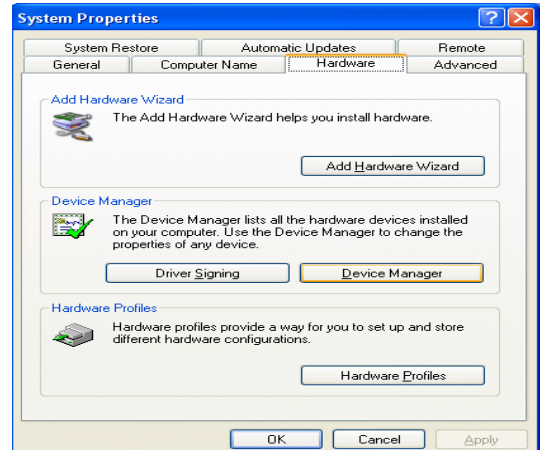

b. Select "Hardware" → "Device Manager" on system properties

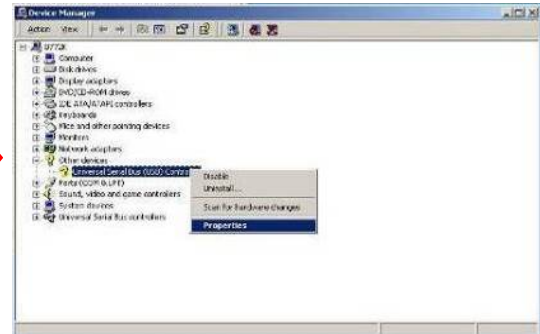
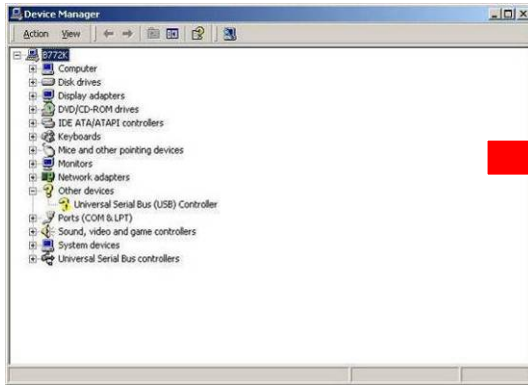

c. Select "Other Devices" → "Universal Serial Bus (USB) Controller" → "Properties" on Device Manager



d. Select "Device" → "Update Driver"



e. Click the "Next" button on the welcome window.



f. Select “Search for a suitable...” and click the “Next” button on the Install Hardware Device Drivers window



g. Select “Specify a location” and click the “Next” button on the Locate Driver Files window.



h. Press “Browse” to select the driver and then click the “OK” button to go to the next page



i. Click the “Next” button on the Driver Files Search Results window.



j. Click the “Finish” button to complete this process.

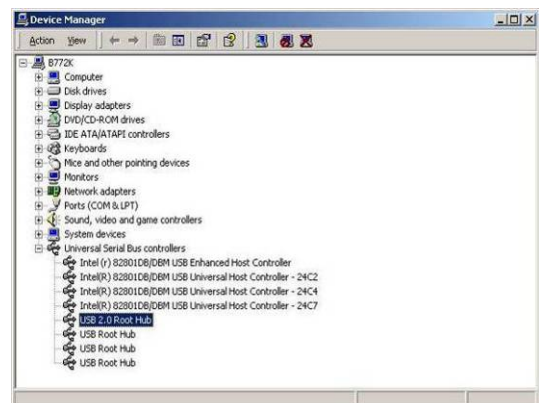

k. Finished.

3-4 VGA Driver Installation

Model name (Motherboard)	Function	OS	Note
	Chipset	Windows	
	USB 2.0	Win9X_ME	
		Win2K	
		WinNT4	
(B78)	VGA	Win9x_ME	Version: 14.19.50
		Win2K_XP	
		Linux	
	Audio	WinNT4	
		Win9X_ME_2K_XP	
		Vista	
		Linux	

a. Click “Win2K_XP” of “VGA” section in the Driver List menu.

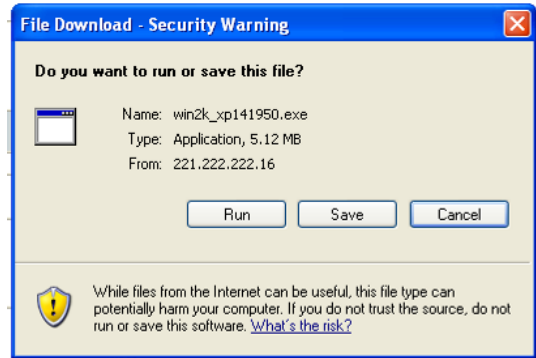

b. Click “Run” when the “File Download – Security Warning” dialog pops up.

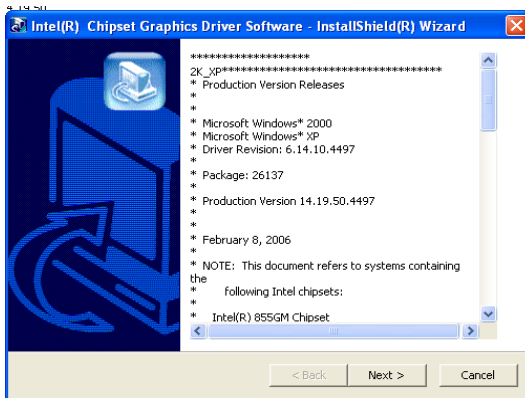

c. Click the “Next” button on the Intel(R) Chipset Graphics Driver Software- Install Shield(R) Wizard dialog.

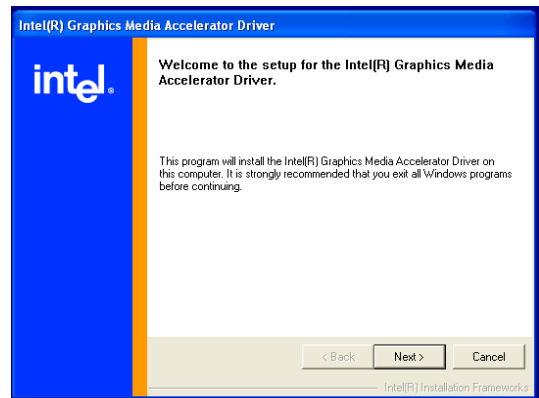

d. Click the “Next” button on the Intel(R) Graphics Media Accelerator Driver dialog.

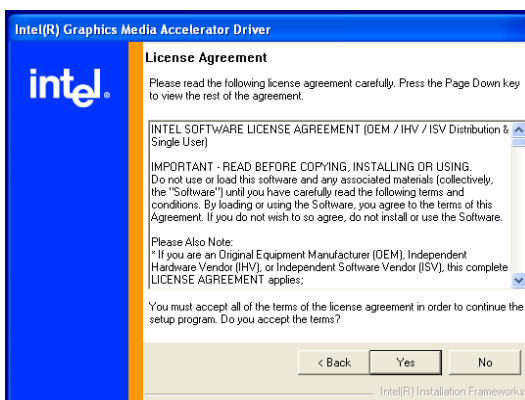

e. Click the “Yes” button on the Intel(R) Graphics Media Accelerator Driver dialog.



f. Select “Yes, I want to restart my computer now” and click the “Finish” button on the Intel(R) Graphics Media Accelerator Driver dialog.

3-5 Audio Driver Installation

Model name (Motherboard)	Function	OS	Note
(B78)	Chipset	Windows	
	USB 2.0	Win9X_ME	
		Win2K	
		WinNT4	
	VGA	Win9X_ME	Version: 14.19.50
		Win2K_XP	
		Linux	
		WinNT4	
	Audio	Win9X_ME_2K_XP	
		Linux	

a. Click “Win9X,ME,2K_XP” of the “Audio” section in the Driver List menu.

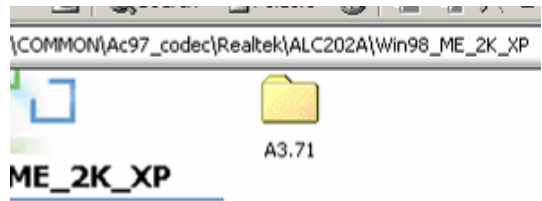

b. Double-click “A3.71” on the My Computer window.

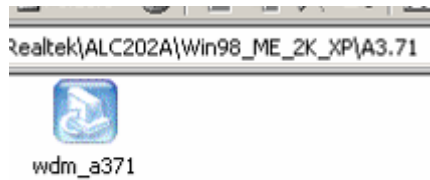

c. Double-click “wdm_a371.exe” on the My Computer window.

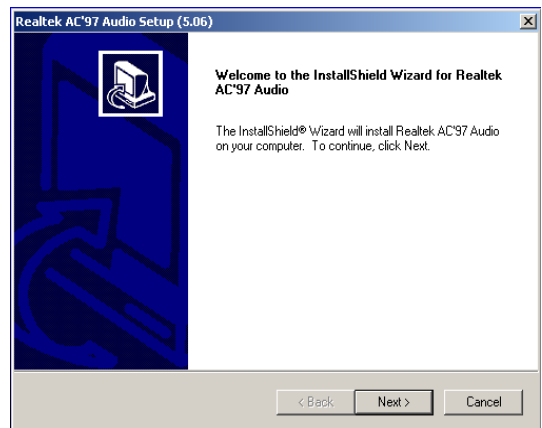

d. Click “Next” button on the Realtek AC’97 Audio Setup window.



e. Click “Yes” button on the Digital Signature Not Found window.

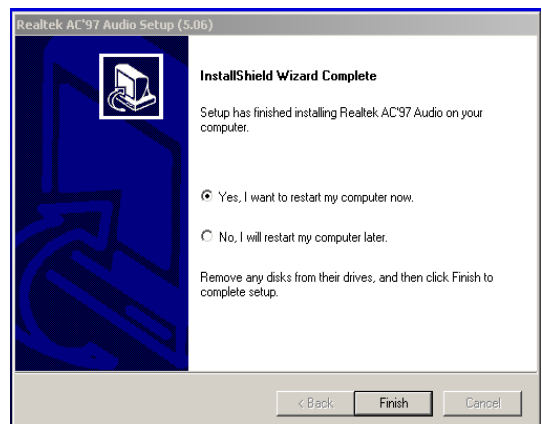

f. Click “Finish” button on the Realtek AC’97 Audio Setup window.

3-6 10/100/1000MB LAN Driver Installation

PCI 100Mb LAN for B78 v1.0	DOS Win9X, ME, 2K, XP
• Realtek RTL8139 / 8100	Vista Linux
PCI 1000Mb LAN for B78 v2.0	DOS Win9X, ME, 2K, XP
• Realtek RTL8110	Vista Linux

a. In the “Realtek RTL8110” section, click on Win9X, ME, 2K, XP



b. Double-click “v709”



c. Double-click Setup.exe

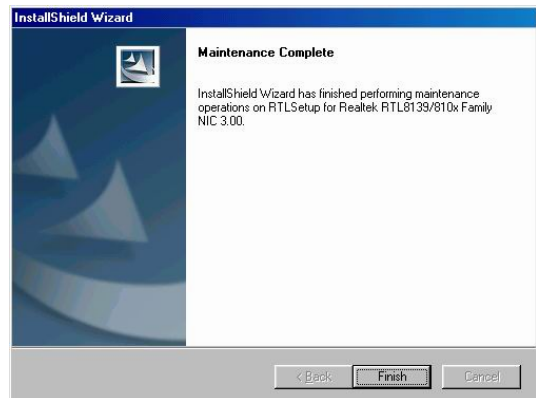

d. Click the Finish button on the Maintenance Complete window.

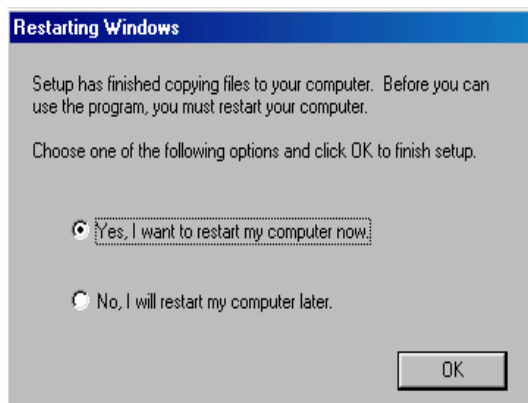

e. Click the OK button and restart your system.

3-7 ELO Touch Driver Installation



a. In the “ELO” section, click on “Windows”.

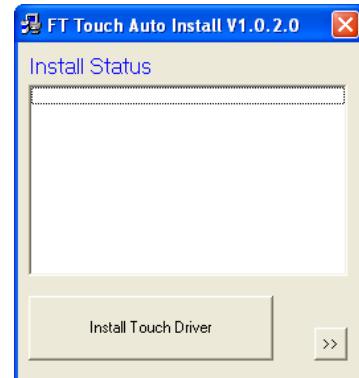

b. Click “Install Touch Driver” on “FT Touch Auto Install V1.0.2.0” window to detect the touch type in your system.

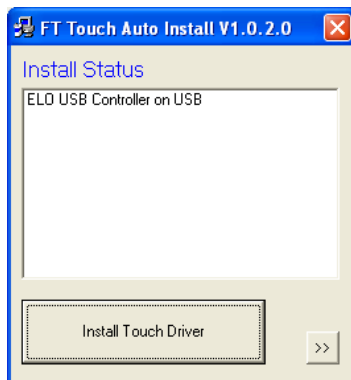

c. Click “Install Touch Driver”.

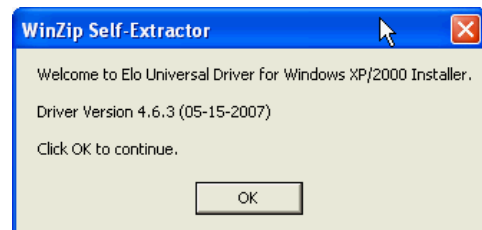

d. A “WinZip Self-Extractor” dialog will pop up. Click “OK”.

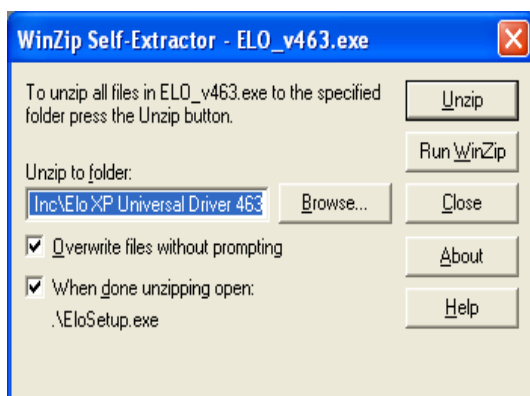

e. Click “Browse” button to identify a location or folder name to save to. Click “Unzip” button to extract the files.



f. Finished unzipping. Click “OK”.

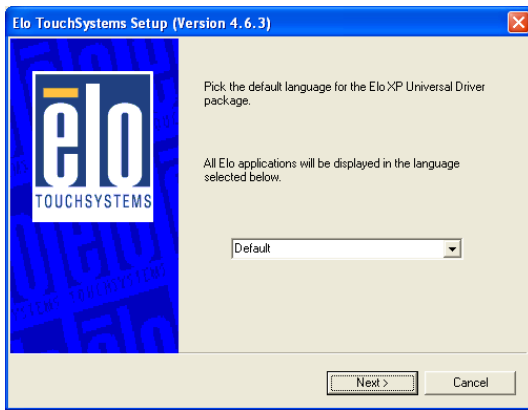

g. Click “Next”.

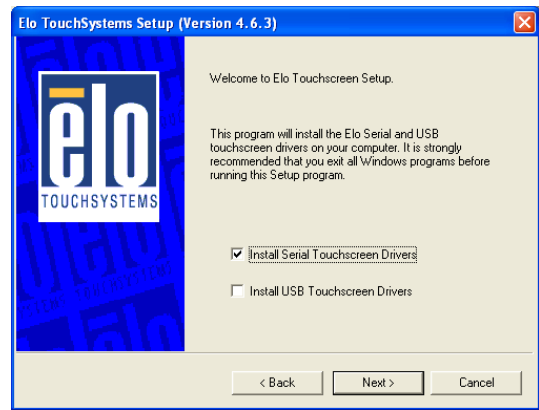

h. Check the “Install Serial Touchscreen Drivers” check box and click “Next”.

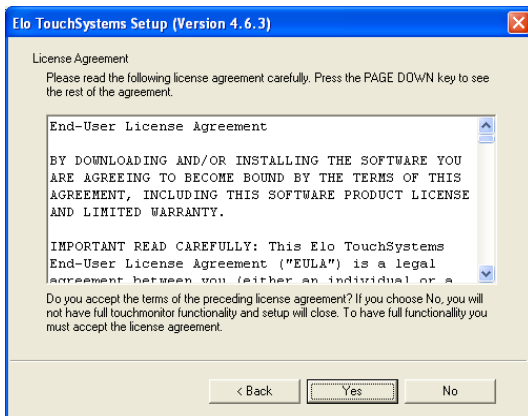

i. Click “Yes” to accept the “End User License Agreement”.

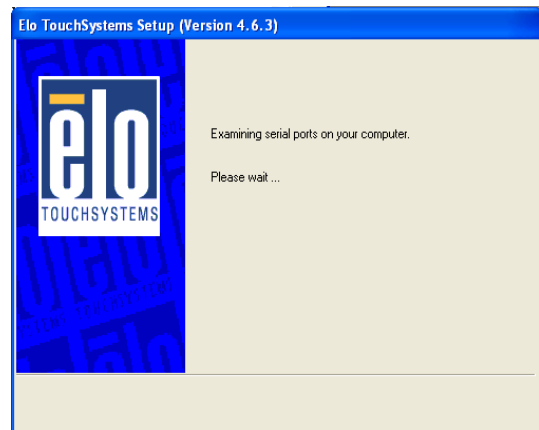

j. Examining serial ports on the computer



k. Check the box “Auto-detect Elo devices” and click “Next”.



l. The computer is searching for a connected to Elo Touchscreen

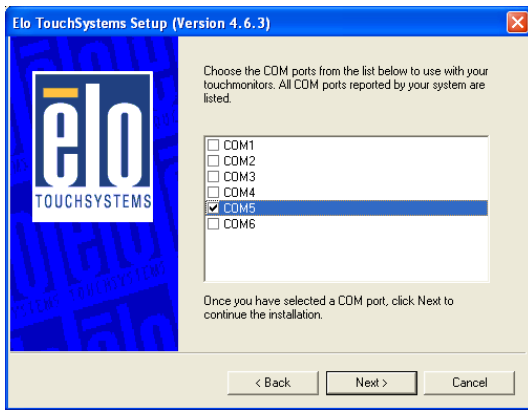

m. Touchscreen found on "COM5".
Click "Next".

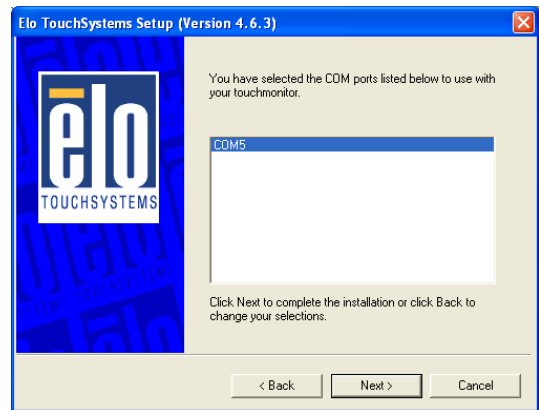

n. Click "Next" to complete the driver installation

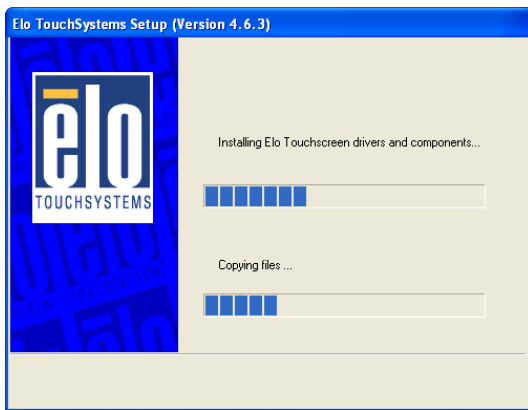

o. Driver is installing



p. The driver installation and setup are now complete. Click "Finish" to start the touchscreen calibration.

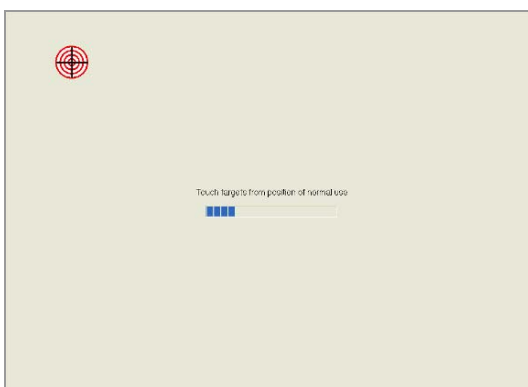

q. Follow the instructions on the screen to calibrate the Touchscreen.

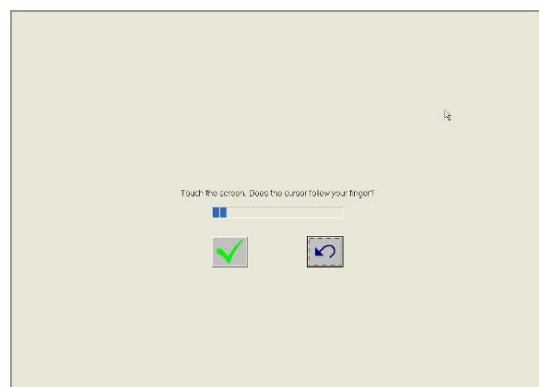

r. Verify that the touchscreen is working correctly by moving your finger on the screen. The mouse cursor should follow your finger. Finally, touch the green checkmark to save the calibration settings and exit the program

3-8 POSTouch Driver Installation

Touch Screen auto detect / install program. Use for:		
<ul style="list-style-type: none">• ELO• POS Touch• POS Touch-HID• POS Touch+	Windows	Read Me
Touch Screen	DOS	
	Windows	v463
	Windows\Alpha	v481 (alpha driver)
	Linux	
Touch Screen	DOS	
	Windows	
	Linux	

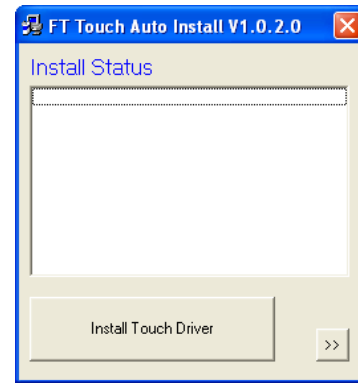

a. In the “Touch Screen auto...” section, click “Windows”.

b. Click “Install Touch Driver” on “FT Touch Auto Install V1.0.2.0” window to detect the touch type in your system.

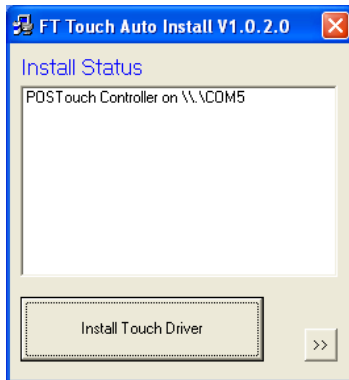

c. “FT Touch Auto Install” program will detect what touch type and interface being installed on the system.

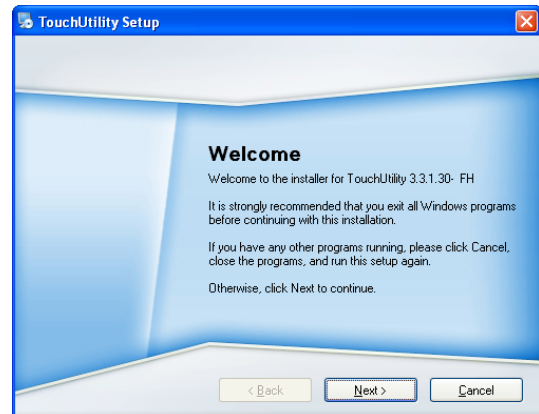

d. Click “Next”.



e. Select “I agree...” and click “Next”.

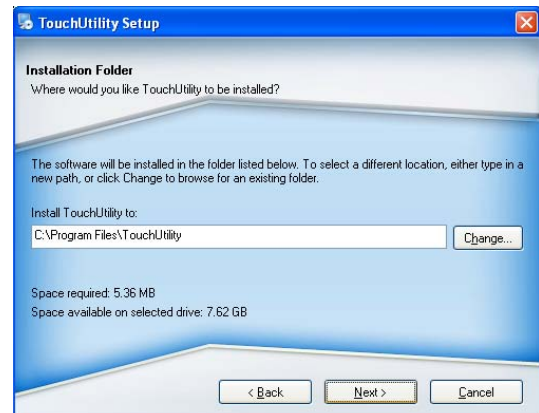

f. Select the installation folder for the touch utility driver and click “Next”.



g. Select the shortcut folder for the touch utility driver and click "Next".



h. Click "Next".

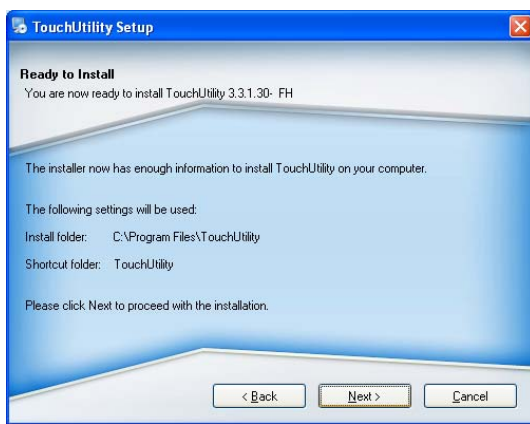

i. Click "Next".

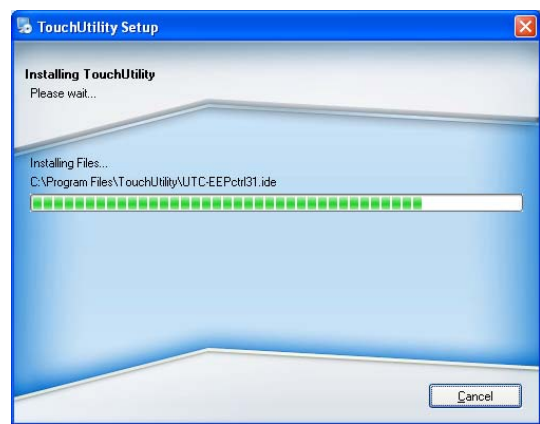

j. The computer is installing the touch driver



k. Click "Continue Anyway" button.



l. The serial ports are scanned for a touch device. The Touch panel is on COM5.

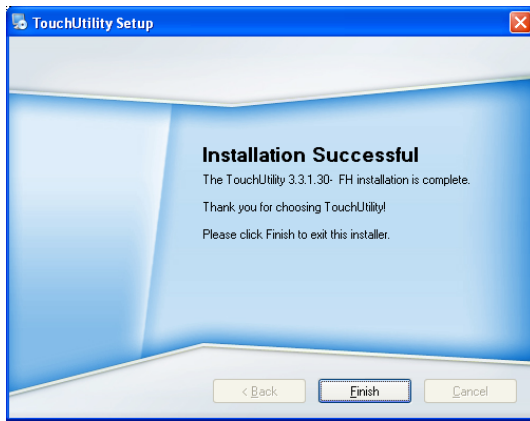

m. Click "Finish".

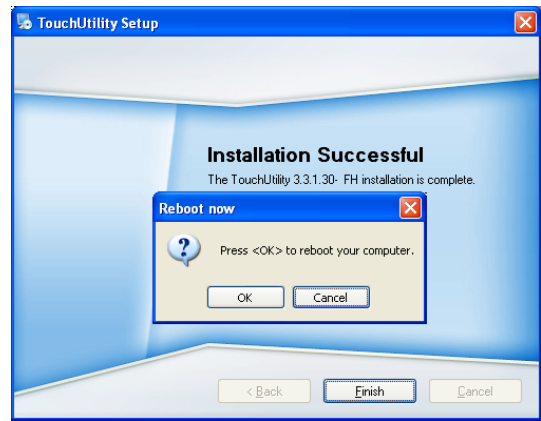

n. Click "OK" to restart the computer and finish the touch utility installation.

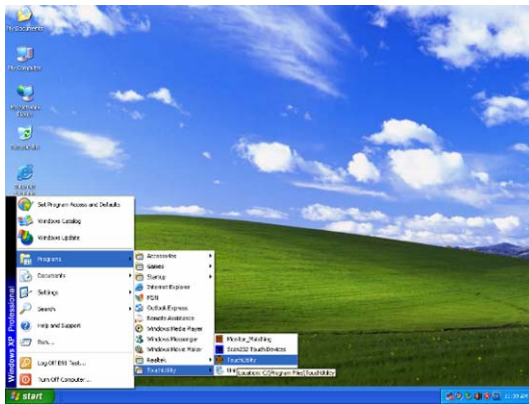

o. The computer has restarted. Click on the "Start" button, select "Programs", then select "Touchutility".

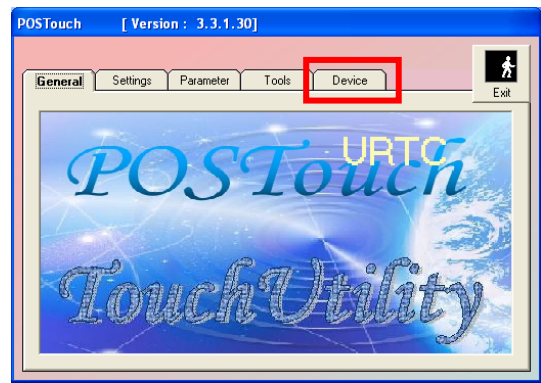

p. Select the Device tab.

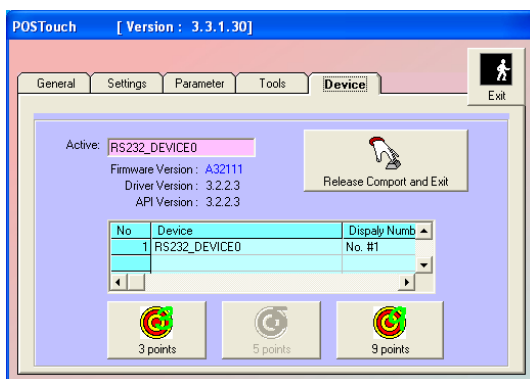

q. Click on the 3 points or the 9 points calibration button.

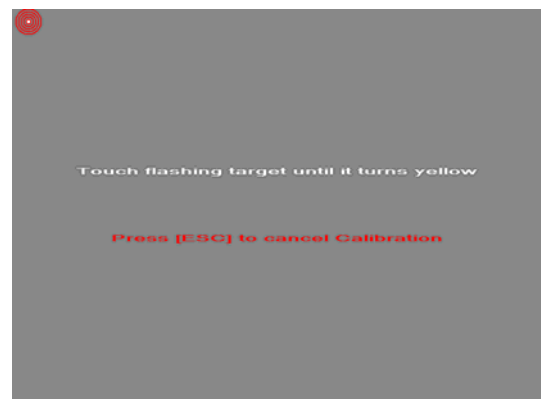

r. Follow the instructions on the screen to do the calibration of the touch panel

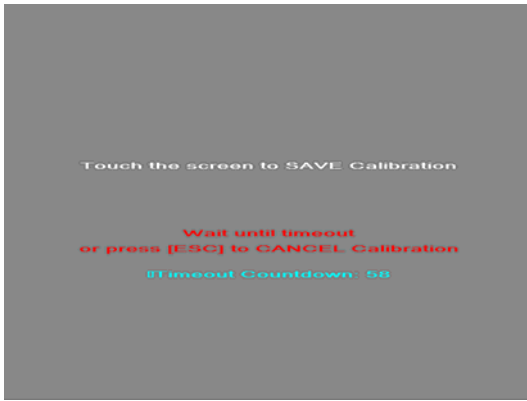

s. Touch anywhere on the screen to save the calibration.

4 Peripherals Installation

4-1 MSR Module Installation

The MSR (Magnetic Card Reader) unit is tested and can be supplied at your request. This MSR is removed during transportation and can be connected by the user. There are two types of MSR Module: RS232 type and keyboard type.



- a. Open the MSR cover by removing the screws (3).

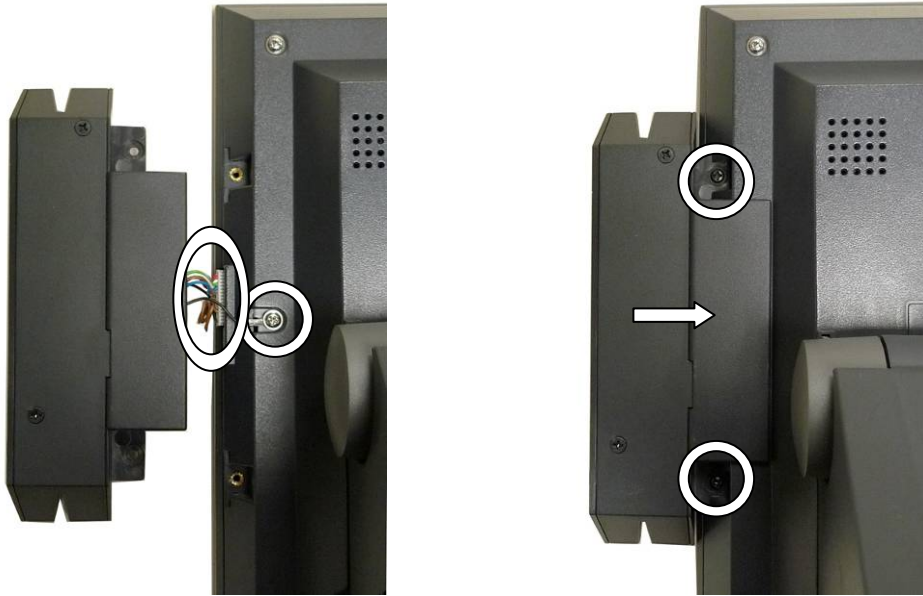

- b. Secure the grounding cable (1) with the screw (1) and connect the MSR cable to the respective connector on the System.
- c. Place the MSR into the right position of the System and fasten the screws (2) to fix the MSR module.

4-2 2-in-1 MSR + Finger Print Module Installation



- Open the MSR Cover first (See Chapter 4.1 (a))
- Connect the Finger Print Cable (1) to the connector on the System.
- Fasten the screw (2) and place the Module into the right position of the System.

4-3 2-in-1 MSR + iButton Module Installation



- Open the MSR Cover first (See Chapter 4.1 (a))
- Connect iButton Cable (1) to the connector on the System.
- Fasten the screw (2) and place the Module into the right position of the System.

4-4 Second Display Installation



- a. Connect the VGA Cable to the Second Display.
- b. Open the VFD cover on the System.



- c. Thread the VGA cable through the VFD hole.
- d. Connect the VGA cable to the System.
- e. Fasten the screws (4) in the metal chassis in the bottom of the System.

4-5 VFD Installation



Accessories of VFD Kit



- a. Thread the VFD Cable (RJ45) through the VFD Pole.
- b. Connect the VFD cable to the connector on the I/O Panel of the System.



- c. Turn the VFD bottom up and connect the other side of the VFD cable to the connector (RJ45) on the VFD.

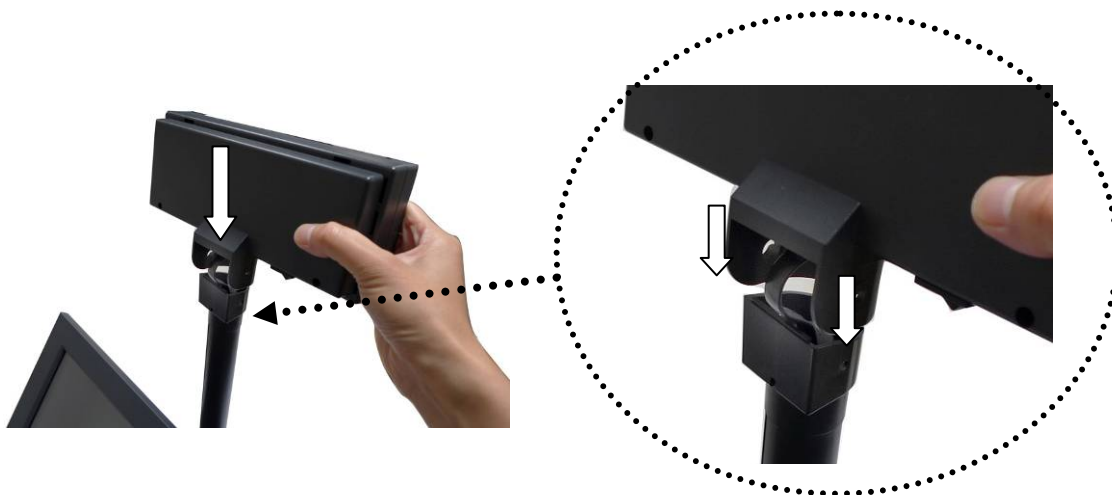

- d. To align and attach the VFD onto the right position of the VFD Pole head.



- e. Detach one plastic wheel from the Wheel Shaft Assembly.
- f. Insert the Wheel Shaft Assembly into aligning hole on the side of the VFD and VFD Pole.



- g. Tighten the plastic wheel with the shaft which comes out from the other side of the aligning hole.

4-6 Cash Drawer Installation

You can install a cash drawer through the cash drawer port. Please verify the pin assignment before installation.

4-6-1 Cash Drawer Pin Assignment

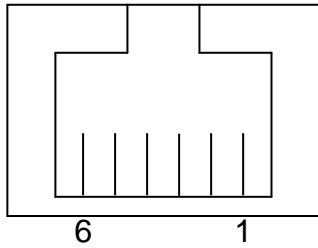

Pin	Signal
1	GND
2	DOUT bit0
3	DIN bit0
4	12V / 19V
5	DOUT bit1
6	GND

4-6-2 Cash Drawer Controller Register

The Cash Drawer Controller use one I/O addresses to control the Cash Drawer.

Register Location: 4B8h

Attribute: Read / Write

Size: 8bit

BIT	BIT7	BIT6	BIT5	BIT4	BIT3	BIT2	BIT1	BIT0
Attribute	Reserved	Reserved	Reserved	Read	Reserved	Write	Write	Reserved

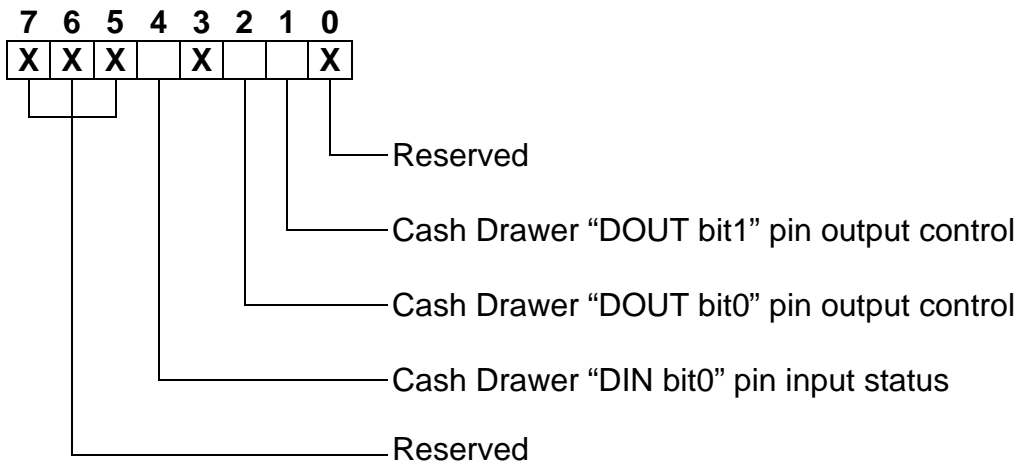

Bit 7: Reserved.

Bit 6: Reserved.

Bit 5: Reserved.

Bit 4: Cash Drawer "DIN bit0" pin input status.

= 1: the Cash Drawer closed or no Cash Drawer.

= 0: the Cash Drawer opened.

Bit 3: Reserved.

Bit 2: Cash Drawer "DOUT bit0" pin output control.

= 1: Opening the Cash Drawer

= 0: Allow closing the Cash Drawer

Bit 1: Cash Drawer "DOUT bit1" pin output control.

= 1: Opening the Cash Drawer

= 0: Allow closing the Cash Drawer

Bit 0: Reserved

Note: Please follow the Cash Drawer control signal design to control the Cash Drawer.

4-6-3 Cash Drawer Control Command Example

Use Debug.EXE program under DOS or Windows98

Command	Cash Drawer
O 4B8 04	Opening
O 4B8 00	Allow to closing

➤ Set the I/O address 4B8h bit2 =1 for opening the Cash Drawer by "DOUT bit0" pin control.

➤ Set the I/O address 4B8h bit2 = 0 to allow closing Cash Drawer.

Command	Cash Drawer
I 4B8	Check status

➤ The I/O address 4B8h bit4 =1 means the Cash Drawer is closed or no Cash Drawer.

➤ The I/O address 4B8h bit4 =0 means the Cash Drawer is open.

5 System Disassembly

5-1 Replacing SATA HDD



- a. Loosen the thumb screws (2) to remove the Motherboard cover.
- b. Disconnect the SATA HDD Cable.



- c. Remove the screws (4) and detach the SATA HDD from the sheet metal chassis.
- d. Loosen the screws (4) on the both sides of the HDD metal bracket and replace the SATA HDD afterwards.

5-2 Replacing the CF Card Holder (Optional)

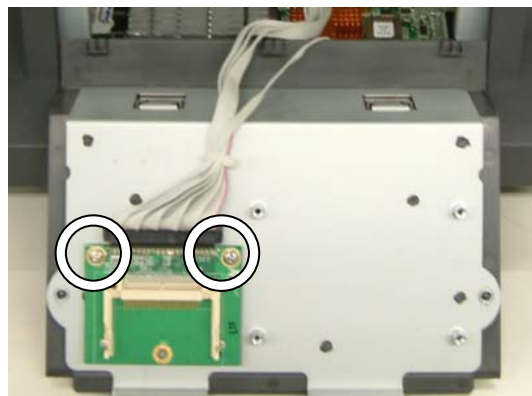

- a. Loosen the thumb screws (2) to remove the Motherboard cover.
- b. Disconnect the IDE cable and remove the screws (2) to replace the CF card holder.

5-3 Replacing Motherboard & I/O Board



- Open the Motherboard Cover first (see Chapter 5.1(a)).
- Unlock the cable clips (2).
- Disconnect all the cables (8) - HDD, LVDS, Inverter, touch, VFD, MSR (if installed), LED light and LCD cables from the connectors on the Motherboard.



- Loosen the screws (4) on each side of the System.
- Lift the LCD Module with the Stand Cover from the Stand Base.



- f. Remove the screws (6) on each side to separate the metal chassis from the stand Base.
- g. Disconnect the power button cable.

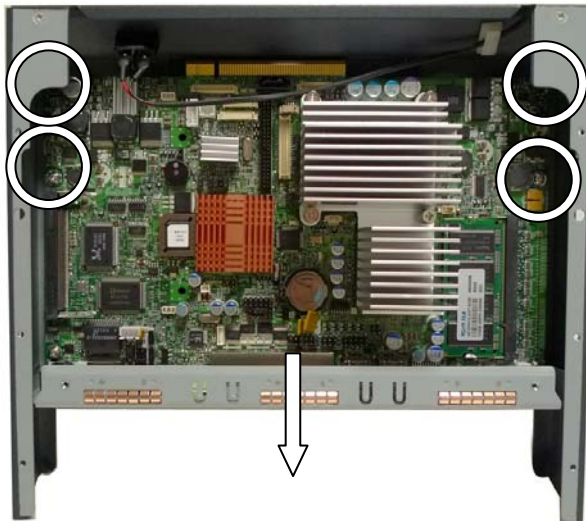

- h. Remove the screws (4) and slide the Motherboard with I/O panel outward as the direction of the arrow shows.

5-4 Replacing Inverter Board & Touch Screen Board



- Open the Motherboard cover and disconnect all the cables connected to the Motherboard first (See Chapter 5.3 (a) (b) (c)).
- Press and pull as the direction of arrows show to remove the hinge cover.
- Remove the screws(6), 3 from each side to separate the display from the base stand.

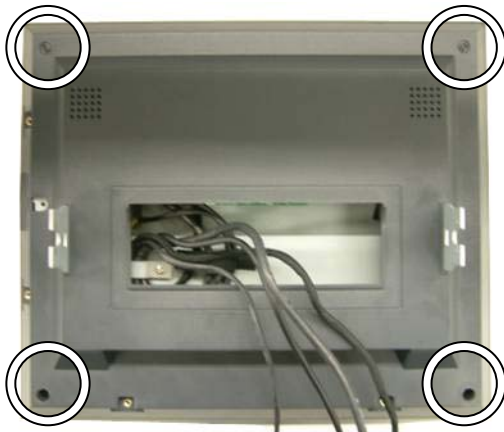

- Remove the screws(4) and separate the back cover from the display head.



- Remove the screws (2) and disconnect the connectors (2) and take out the Inverter Board.

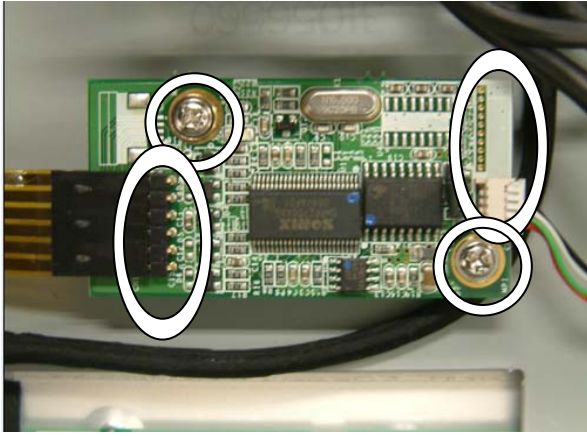

- f. Remove the screws (2) and disconnect the Cables (2) to take out the Touch Board.

6 Specification

Motherboard	B78 v2.2	
CPU Support	Intel Celeron M ULV 600MHz/ 1GHz	
Chipset	Intel 852GM + ICH4	
System Memory	256MB DDR RAM, up to 2GB	
Graphic Memory	Shared system memory up to 64MB	
LCD Panel		
LCD Size	12.1" TFT	15" TFT
Brightness	up to 400 cd / m ²	250 - 350 cd / m ²
Maximal Resolution	800 x 600 / 1024 x 768	1024 x 768
Touch Screen Type	Resistive	
Tilt Angle	-25° ~ 65°	
Storage		
HDD	2.5" 40GB or higher	
Flash Memory	Compact Flash (Type I&II)	
Expansion		
Mini-PCI Socket	1	
Base Rear I / O		
USB	4 (V2.0)	
Serial/COM	4 x COM ports RJ-45 connectors (COM1 standard RS-232; COM2 RS232/422/485 selectable by jumper; COM3 & COM4 pin 9 with 5V or 12V power by jumper)	
Parallel	1 x D-sub 25-pin connector	
LAN (10 / 100)	1 x RJ45	
2 nd VGA Output	1	
Cash Drawer	1 x RJ-11 (12V or 19V) by jumper	
MIC-in	1	
Line-out	1	
Control/Indicator		
Power Button	1	
Indicator LED	1	
Power		
Power Adapter	90W (DC 19V)	
Dimension (W x D x H)	385 X 265 X 384mm	308 X 265 X 356mm

Peripherals	
Customer Display	Pole mounted type (VFD/ LCD type)
Magnetic Card Reader	3 Tracks (RS-232 (COM6) / PS2 interface)
Second Display	10.4" or 12.1" LCD Second Display
Environment	
Operating Temperature	5°C ~ 35°C (41°F ~ 95°F)
Storage Temperature	-20°C ~ 55°C (-4°F ~ 140°F)
Operating Humidity	20% - 80% RH non condensing
Storage Humidity	20% - 85% RH non condensing
OS Support	Windows XP, WEPOS, XP Embedded, XP professional for Embedded, WIN 2000/NT 4.0

7 Jumper Settings

B78 v2.2 Motherboard

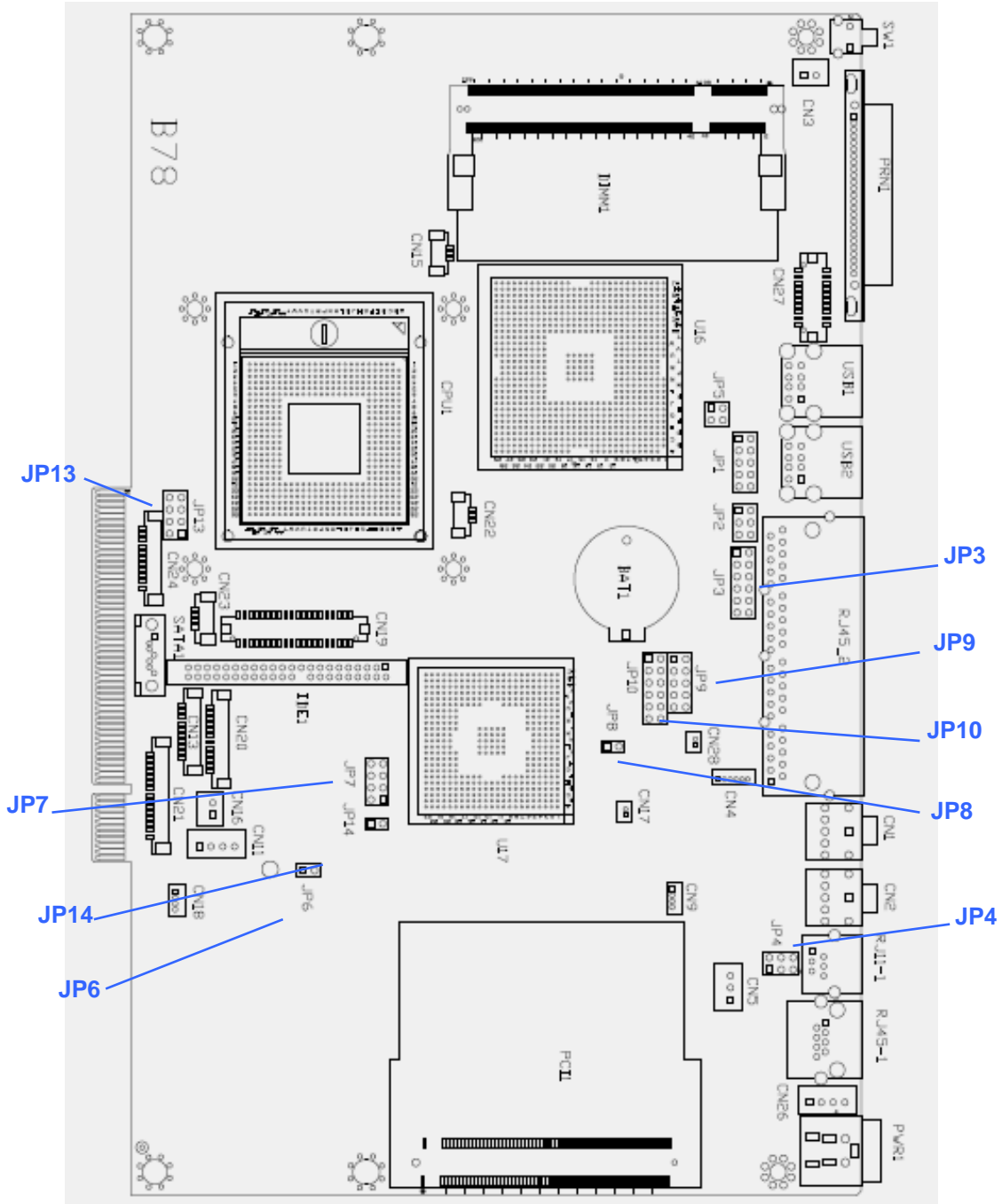

7-1 B78 v2.2 Jumper Settings

The diagram below illustrates the default jumper settings for the Main Board. An asterisk (*) indicates the default setting.

7-1-1 Connectors & Function

Connector	Function
BAT1	CMOS Battery Base (Use CR2023)
CN1	Audio Line Out
CN2	Audio MIC In
CN3	Internal Power Switch
CN4	Speaker & MIC Connector
CN9	CD-IN Connector
CN11	Power Connector For 3.5" HDD
CN13	COM5 for Touch
CN15	CPU FAN Connector
CN16	Hardware Reset
CN18	USB2
CN19	LCD Interface Connector
CN20	Inverter Connector
CN21	Card Reader Connector
CN22	System FAN Connector
CN23	IrDA Connector
CN24	FT Status Interface
CN26	Internal Power In Connector
CN27	Internal LPT Connector
CN28	Internal PCI Reset Output Connector
IED1	Secondary IDE Connector (Pitch = 2.0mm)
PRN1	Parallel Port
PWR1	+19V Power Adaptor
RJ11_1	Cash Drawer Connector
RJ45_1	LAN (On Board)
RJ45_2	COM1, COM2, COM3, COM4
SATA1	SATA Connector
USB1	USB3, USB4
USB2	USB5, USB6
JP1	VGA Port
JP2	VGA Power

COM2 RS232/485/422 Setting

Function	JP10						JP9					
	(1-2)	(3-4)	(5-6)	(7-8)	(9-10)	(11-12)	(1-2)	(3-4)	(4-6)	(5-7)	(7-8)	(9-10)
◎RS232												
RS485												
RS422												

RJ45 pin	RS_232	RS_485	RS_422	DB9 pin
1	---	NC	NC	---
2	DCD#	RS485_TXRX-	RS422_TX-	1
3	DSR#	NC	NC	6
4	RX#	RS485_TXRX+	RS422_TX+	2
5	RTS#	NC	NC	7
6	TX#	NC	RS422_RX+	3
7	CTS#	NC	NC	8
8	DTR#	NC	RS422_RX-	4
9	GND	GND	GND	5
10	RI#	NC	NC	9

◎ = Default

COM3 & COM4 Power Setting

Function		JP3 (1-2) (3-4) (5-6) (7-8) (9-10) (11-12)
COM3 Pin10	⊙RI	
	+5V	
	+12V	
COM4 Pin10	⊙RI	
	+5V	
	+12V	

Cash Drawer Power Setting

Function	JP4 (1-2) (3-4) 5-6
+12V	
⊙+19V	

⊙ = Default

LCD ID Setting

Panel #	Resolution	LVDS		JP7
		Bits	Channel	(1-2) (3-4) (5-6) (7-8)
1	1024 x 768	24	Single	
2	1024 x 768	24	Single	

Note:

Panel 1 Jumper Setting is for SVA-NEC panel
 Panel 2 Jumper Setting is for other LCD Panel.

Power Mode Setting

Function	JP6 (1-2)
Ⓒ ATX Power	
AT Power	

CMOS Operation Mode

Function	JP8 (1-2)
Ⓒ CMOS Normal	
CMOS Reset	

USB Path Setting (do not change)

Function	JP14 (1-2)
To Docking	
Ⓒ To Motherboard	

System Indicator Function (do not change)

Function	JP13																			
	(1-2)	(3-4)	(5-6)	(7-8)																
Ⓒ Disable			<table border="1"> <tr><td>1</td><td>3</td><td>5</td><td>7</td></tr> <tr><td>■</td><td>■</td><td>□</td><td>□</td></tr> <tr><td>■</td><td>■</td><td>□</td><td>□</td></tr> <tr><td>2</td><td>4</td><td>6</td><td>8</td></tr> </table>	1	3	5	7	■	■	□	□	■	■	□	□	2	4	6	8	
1	3	5	7																	
■	■	□	□																	
■	■	□	□																	
2	4	6	8																	
Enable			<table border="1"> <tr><td>1</td><td>3</td><td>5</td><td>7</td></tr> <tr><td>□</td><td>□</td><td>■</td><td>■</td></tr> <tr><td>□</td><td>□</td><td>■</td><td>■</td></tr> <tr><td>2</td><td>4</td><td>6</td><td>8</td></tr> </table>	1	3	5	7	□	□	■	■	□	□	■	■	2	4	6	8	
1	3	5	7																	
□	□	■	■																	
□	□	■	■																	
2	4	6	8																	

Ⓒ = Default

Note:

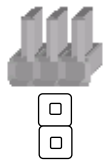

OPEN



SHORT

8

BIOS Settings

8-1 BIOS Setup Utility

The BIOS setup defines how the system is configured. You need to run this program the first time you configure this product. You may need to run it again if you change the configuration.

You need to connect a PC keyboard to the keyboard connector to run the BIOS setup utility.

8-2 Starting the BIOS Setup

Turn on or reboot this product.

Press the DEL key immediately after the product is turned on, or press the DEL key when the following message is displayed during POST (the Power on Self-Test)

Press DEL to enter SETUP.

The main menu of the BIOS setup is displayed.

If the supervisor password is set, you must enter it here.

8-3 When a Problem Occurs

If, after making and saving system changes with the Setup utility, you find that this product no longer boots, start the BIOS setup and execute the following

Load Optimized Defaults

8-4 BIOS Main Menu

When the BIOS Main Menu is displayed, the following items can be selected. Use the arrow keys to select items and the Enter key to accept and enter the sub-menu.

Note: The BIOS setup menus shown in this section are for reference only and may not exactly match the items of your BIOS version.

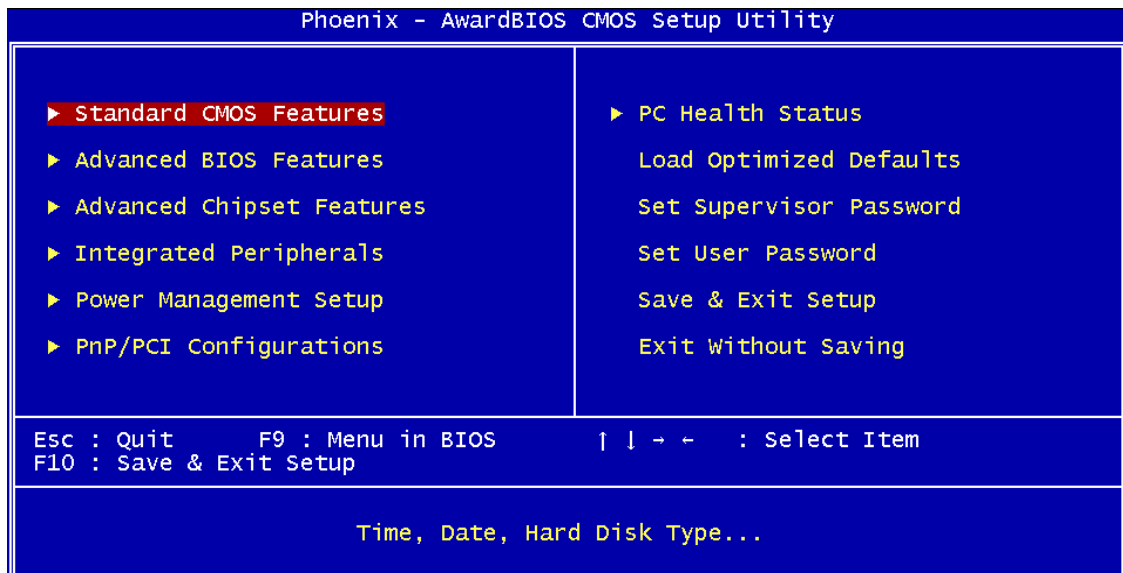

Standard CMOS Features

Use this menu for basic system configuration.

Advanced BIOS Features

Use this menu to set the Advanced Features available on the system.

Advanced Chipset Features

Use this menu to change the values in the chipset registers and optimize the system's performance.

Integrated Peripherals

Use this menu to specify your settings for integrated peripherals.

Power Management setup

Use this menu to specify your settings for power management.

PnP/PCI Configurations

This entry appears if your system supports Plug and Play and PCI Configuration.

PC health status

Displays CPU, System Temperature, Fan Speed, and System Voltages Value.

Load Optimized Defaults

Use this menu to load the BIOS default values, i.e., factory settings for optimal performance system operations. While Award has designed the custom BIOS to maximize performance, the factory has the option to change these defaults to meet their needs.

Set Supervisor Password

Enables you to change, set, or disable the supervisor or user password.

Set Password

Change, set, or disable the password. It allows you to limit access to the system and to the setup, or just to the setup.

Save & exit setup

Save CMOS value changes to CMOS and exits setup.

Exit without saving

Ignores all CMOS value changes and exits setup.